

**RJX**  
TACTICAL



# RIP-3C

User Manual V1.0



**01** ...02  
PRODUCT OVERVIEW

**05** ...08  
POWER SUPPLY

**09** ...12  
BUTTONS OPERATIONS

**13** ...18  
LEGAL AND REGULATORY  
INFORMATION

# ▼ TABLE OF CONTENTS

**02** ...03  
PRODUCT FEATURES

**03** ...04  
PRODUCT PARAMETERS

**04** ...05  
PRODUCT APPEARANCE

**06** ...09  
LED ILLUMINATOR

**07** ...10  
MOUNTING

**08** ...11  
WINDAGE&ELEVATION  
ADJUSTMENT

**10** ...15  
SMART REMOTE  
SWITCH

**11** ...16  
INDICATOR LIGHT GUIDE

**12** ...17  
PRODUCT  
MAINTENANCE

## ▼01 PRODUCT OVERVIEW

The RIP-3C is a multi-laser aiming system equipped with visible laser, IR laser and IR illuminator. The range of IR laser beam can reach up to 550 yards. When paired with night vision devices, built-in IR illuminator and IR aiming laser improve the accuracy for long range aiming. Its compact design allows it to be positioned lower on the rail than most other lasers, weighing approximately 8 oz. The performance of VCSEL infrared illuminator is excellent, providing a clear and adjustable infrared spot.

## 02 PRODUCT FEATURES

RIP-3C
<b>All-in-one tactical laser sight</b> —integrating illumination and targeting capabilities.
<b>Co-aligned components</b> —IR laser always remains centered within the IR illuminator.
<b>Class 3a laser power</b> —available to the general public with a 550-yard aiming distance.
<b>VCSEL IR illuminator</b> —features a round, clear, and adjustable infrared spot.
<b>Windage &amp; Elevation adjusters</b> —precisely tuned with 0.25 mil click values.
<b>Mounting</b> —compatible with Picatinny rails, with 1000G impact resistance.
<b>Compact design</b> —dimensions: 4.17 × 2.44 × 1.65 inches.
<b>Smart remote switch</b> —compatible with Picatinny rails, M-LOK, and Velcro.
<b>IP67 waterproof rating</b> —durable in extreme environments.
<b>Low battery indicator light</b> —provides real-time power status updates.

# 03 PRODUCT PARAMETERS

RIP-3C		
Laser & Illuminator Output	Green Laser	520±15nm, Class 3a
	IR Laser	820±15nm, Class 3a
	IR Illuminator	850±15nm, Class 3a
	IR Illuminator Divergence( FWHM)	45~140 mrad
	LED Illuminator Output	< 120 lm
	Windage / Elevation	0.25 mil per click
Range Performance	Detection Range	550 yards
Specifications Characteristics	Waterproof Rating	IP 67
	Operating Temperature	-4 to 122 °F
	Storage Temperature	-27.4 to 140°F
	Shock Resistance	1000 G
Power & Dimensions	Battery Type	CR123 A*1
	Dimensions	4.17*2.44*1.65 inches
	Weight	< 0.5 lb

## ▼04 PRODUCT APPEARANCE

Included in the Box

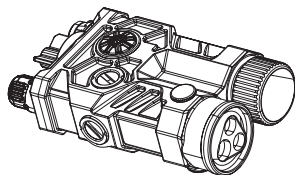

RIP-3C Device

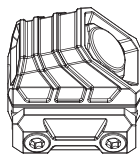

Smart Remote Switch

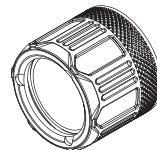

LED Illuminator

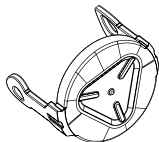

Lens Cap

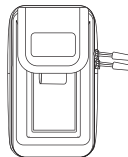

Portable Bag

### NOTE

User Manual, a Quick-Use Guide, Thank You Letter and Warranty Card.

# 04 PRODUCT APPEARANCE

## Key Components

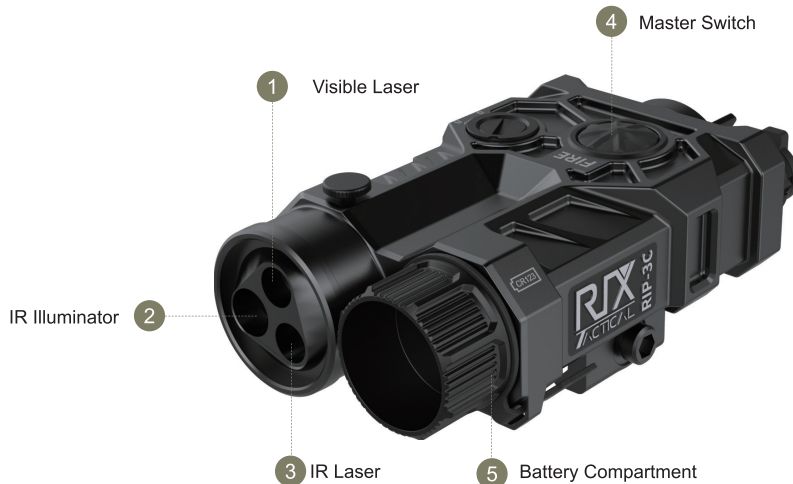



# 04 PRODUCT APPEARANCE

## Key Components

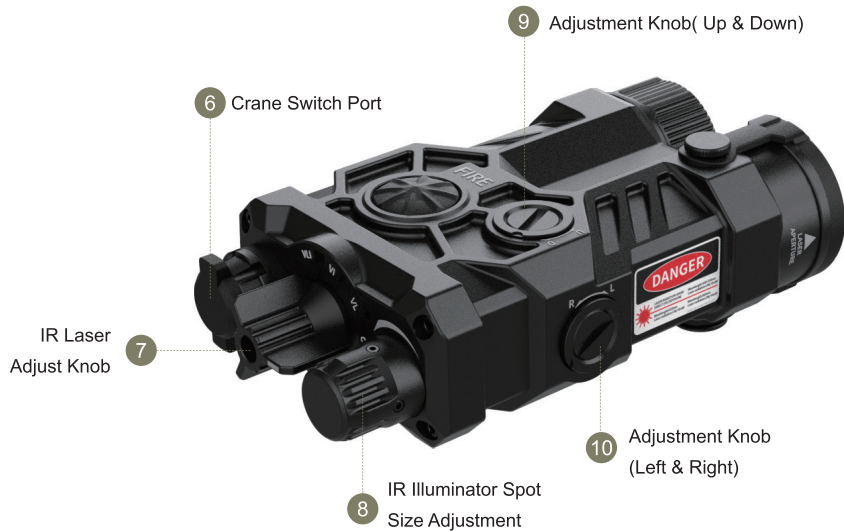

## ▼05 POWER SUPPLY

- » Open the battery compartment by rotating the cover.
- » Insert the CR123A battery (positive "+" side outward, negative "-" inward) as indicated.
- » Securely close the battery cover.

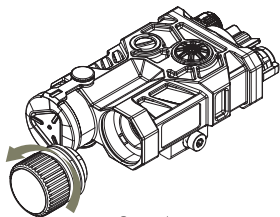

Step 1

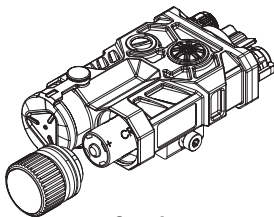

Step 2

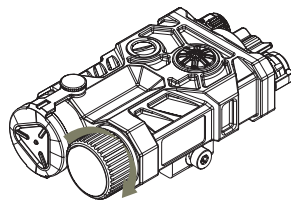

Step 3

### WARNING

- » Remove the battery if the device will not be used for an extended length of time.
- » Do not use damaged or modified batteries.
- » Do not use the battery at a temperature above 122°F as this may shorten battery life.

## ▼06 LED ILLUMINATOR

- » Open the battery compartment cover.
- » Install and secure the LED illuminator.

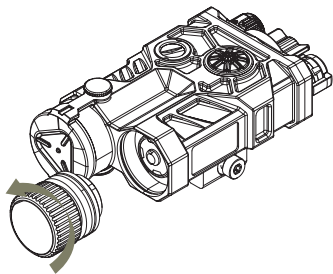

Step 1

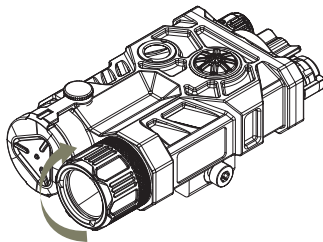

Step 2

## ▼07 MOUNTING

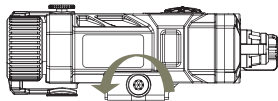

Step 1

Loosen the locking knob and open the Picatinny rail slot.

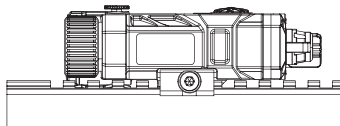

Step 2

Align the device's guide rail with the Picatinny slot and click it into place.

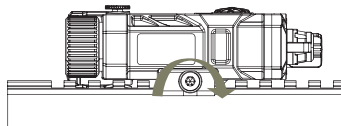

Step 3

Tighten the locking knob securely.

# ▼08 WINDAGE&ELEVATION ADJUSTMENT ADJUSTOR

» It is recommended to use a shell casing to adjust the dials as needed.

Adjuster	Position	Direction	Effect
Elevation	Top	CW (D)	Moves Down
		CCW (U)	Moves Up
Windage	Side	CW (L)	Moves Left
		CCW (R)	Moves Right

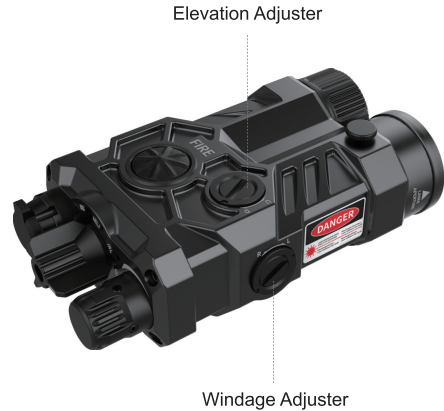

## ▼09 BUTTONS OPERATIONS

» Rotate the gear switch to select different working modes.

Position	Function
OFF	Turns off the device
VL	Turns off the device
VI	Visible Illuminator
VLI	Visible Laser + LED Illuminator
IRL	IR Laser
IRLI	IR Illuminator
IRLI	IR Laser + IR Illuminator



### NOTE

All the working mode could continuous working for 5 minutes, if there is no more operation, device will enter into dormant state.

## ▼09 BUTTONS OPERATIONS

- » Master Switch: Activates all modes.
- » Hold the master switch for momentary activation. Release to turn off.
- » Double-click the master switch to lock a mode.
- » Click once to turn off.



## ▼09 BUTTONS OPERATIONS

» The IR illuminator spot size is adjusted via the knob.

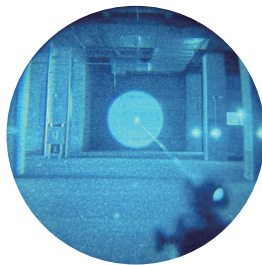
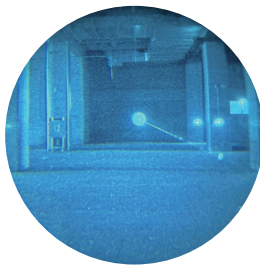
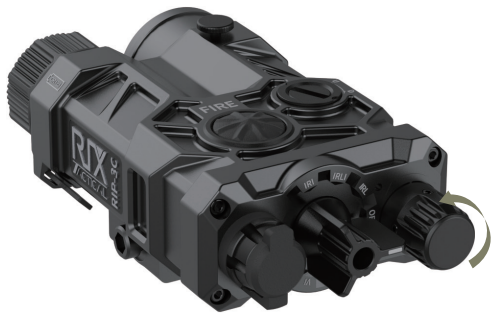



## ▼10 SMART REMOTE SWITCH

- » Remove the protective cover from the remote switch port.
- » Insert the remote switch fully into the port.

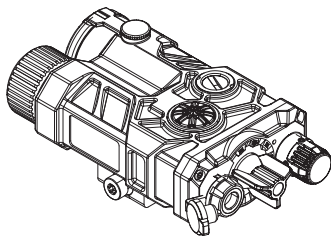

Step 1

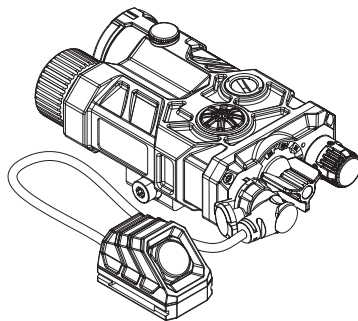

Step 2

# ▼11 INDICATOR LIGHT GUIDE

Mode	Indicator Light
OFF	No Light
VL	Green
IRL	Red
Low Battery	Blinking Green / Red



## ▼12 PRODUCT MAINTENANCE

- » Inspect the device before use to ensure optimal performance.
- » Clean the metal and plastic parts with a soft cotton cloth.
- » Check the battery for damage—do not use if bulging or deformed.

## 13 LEGAL AND REGULATORY INFORMATION

### Labeling Requirements

This device complies with part 15 of the FCC Rules. Operation is subject to the following two conditions:

- (1) This device may not cause harmful interference.
- (2) This device must accept any interference received, including interference that may cause undesired operation.

### Information To The User

Any changes or modifications not expressly approved by the party responsible for compliance could void the user's authority to operate the equipment.

### EMC Class B

#### NOTE

This equipment has been tested and found to comply with the limits for a Class B digital device, pursuant to part 15 of the FCC Rules. These limits are designed to provide reasonable protection against harmful

## 13 LEGAL AND REGULATORY INFORMATION

interference in a residential installation. This equipment generates, uses and can radiate radio frequency energy and, if not installed and used in accordance with the instructions, may cause harmful interference to radio communications. However, there is no guarantee that interference will not occur in a particular installation. If this equipment does cause harmful interference to radio or television reception, which can be determined by turning the equipment off and on, the user is encouraged to try to correct the interference by one or more of the following measures:

- Reorient or relocate the receiving antenna.
- Increase the separation between the equipment and receiver.
- Connect the equipment into an outlet on a circuit different from that to which the receiver is connected.
- Consult the dealer or an experienced radio/TV technician for help.

# 13 LEGAL AND REGULATORY INFORMATION

## Laser Safety Warning CLASS IIIa LASER PRODUCT



Avoid direct eye exposure

Wavelengths: 505-535nm (Green Laser), 805-865nm (IR Laser)

Power: <5mW (Green Laser), <3mW (IR Laser)

Caution-use of controls or adjustments or performance of procedures other than those specified herein may result in hazardous radiation exposure.





▼**2**

YEAR WARRANTY  
ON LASER & ILLUMINATION  
COMPONENTS